

30 V & 40 V Automotive-Grade N-Channel MOSFET

AEC-Q101 qualified with 175°C junction temperature

PANJIT's latest N-channel power MOSFETs are designed with advanced trench technology to provide excellent figure of merit(FOM), lower $R_{DS(ON)}$ and capacitance. The new design reduces conduction losses and switching losses while boosting electrical performances. They are available in DFN3333-8L, DFN5060-8L, DFN5060B-8L, TO-252AA, TOLL, and sTOLL packages, which are low profile packages that save spaces. PANJIT offers a comprehensive solution for highly efficient, reliable and space saving PCB layout applications.

► Features

- 30 V & 40 V N-channel advanced trench
- Low $R_{DS(ON)}$ to minimize conduction losses
- Low FOM to minimize driver losses
- Standard and logic level available
- AEC-Q101 qualified and PPAP capable
- 175°C operating junction temperature

► Block Diagrams

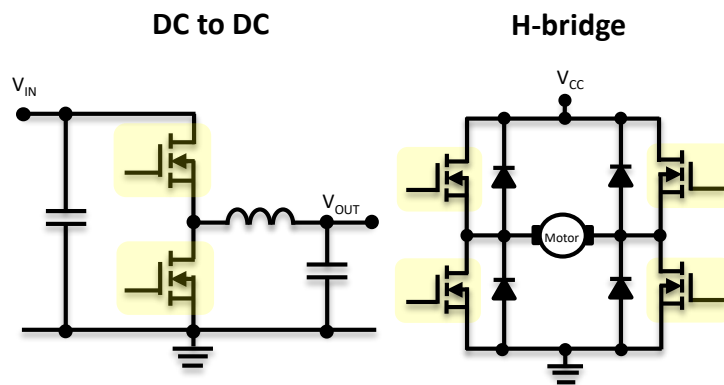

► Figure of Merit (FOM)

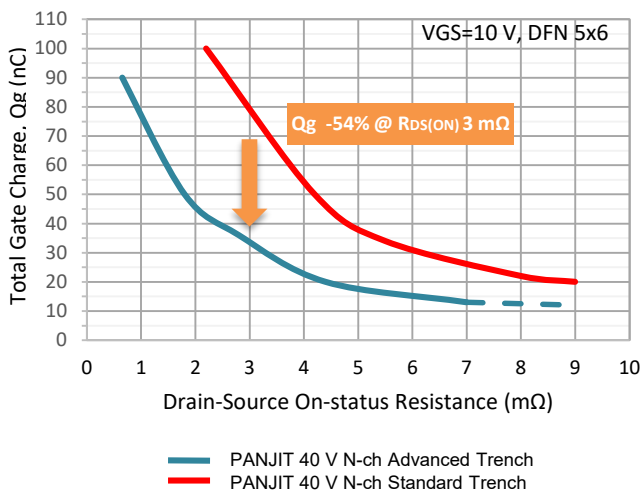

► Gate Charge Characteristic

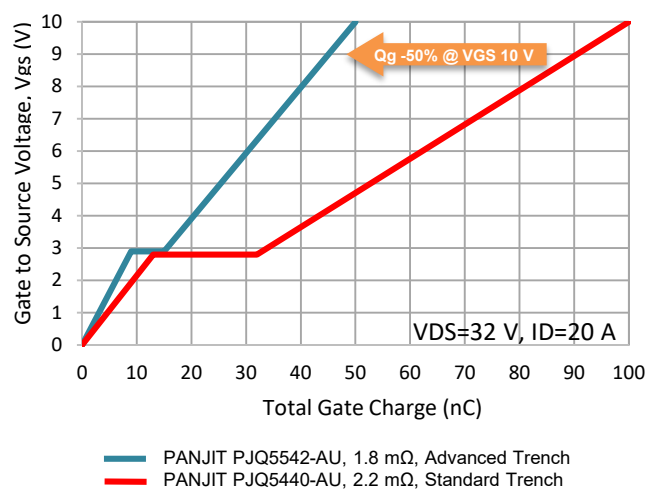

➤ Applications

Automotive



- Power motor drive
- Oil & water pumps
- Infotainment
- ADAS
- Sensor

Power System



- Power supply
- LED lighting
- DC power tool
- Control board
- BMS

Industrial

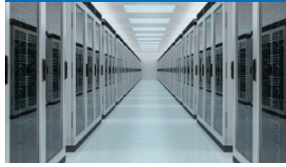







- Data center
- Telecom
- Server
- Robot
- DC Fan

Consumer



- Wireless charger
- Quick charger
- Vacuum cleaner
- Small appliance
- Drone

➤ Products

Series	V _{DS}	V _{GS}	V _{GS(th)} Max.	DFN3333-8L	DFN5060-8L	DFN5060B-8L	TO-252AA	TOLL	sTOLL
	(V)	(V)	(V)						
30 V Logic Level	30	±20	1.6	PJQ4534P-AU	PJQ5534-AU				
				PJQ4530P-AU	PJQ5530-AU				
				PJQ4528P-AU	PJQ5528-AU				
				PJQ4526P-AU	PJQ5526-AU				
				PJQ4524P-AU	PJQ5524-AU				
					PJQ5522-AU				
					PJQ5520-AU				
					PJQ5518C-AU				
40 V Logic Level	40	±20	1.6	PJQ4548P-AU	PJQ5548-AU	PJQ5948-AU	PJD30N04S-AU		
				PJQ4546P-AU	PJQ5546-AU	PJQ5946-AU	PJD55N04S-AU		
					PJQ5544-AU		PJD60N04S-AU		
					PJQ5542-AU		PJD65N04S-AU		
					PJQ5540-AU		PJD80N04S-AU		
					PJQ5540C-AU			PJM250N04S-AU*	PJM180N04S-AU*
40 V Standard Level	40	±20	2.8	PJQ4548VP-AU	PJQ5548V-AU	PJQ5948V-AU	PJD25N04V-AU		
				PJQ4546VP-AU	PJQ5546V-AU	PJQ5946V-AU	PJD50N04V-AU		
					PJQ5544V-AU		PJD55N04V-AU		
					PJQ5542V-AU		PJD60N04V-AU		
					PJQ5540V-AU		PJD75N04V-AU		
					PJQ5540VC-AU			PJN250N04V-AU*	PJM180N04V-AU*
					PJQ5538VC-AU			PJM280N04V-AU*	PJM200N04V-AU*

* Under development with samples available